

- Selection Guide..... 150
- PS6R Standard Series..... 151
 - Part Numbers..... 151
 - Specifications..... 152
 - Dimensions..... 154
- PS5R Slim Line Series..... 157
 - Part Numbers..... 158
 - Specifications..... 159
 - Dimensions and Terminal Markings..... 161
- PS5R Standard Series..... 163
 - Part Numbers..... 163
 - Specifications..... 164
 - Dimensions..... 167
- PS3X Series..... 168
 - Part Numbers..... 168
 - Specifications..... 169
 - Dimensions..... 171
 - Safety Precautions..... 173













Power Supplies



www.IDEC.com/powersupply



Selection Guide

Series	PS6R	PS5R Slim Line	PS5R	PS3X	PS3L
Appearance					
Page	151	157	163	168	Visit www.IDEC.com/powersupply
Housing	Metal	Plastic		Metal	Metal
Mounting	DIN Rail	DIN Rail or surface mount		Direct or DIN Rail mount	Panel or bracket mount
Wattage Range	120W to 480W	10W to 240W	7.5W to 480W	15W to 100W	10W to 300W
Input Voltage	100 to 240 V A, 110 to 350V DC	85 to 264 V AC, 100-370 V DC (100-350V DC, 120W & 240W)	85 to 264V AC, 105 to 370V DC	85 to 264V AC, 120 to 375V DC	85 to 264V AC, 105 to 370V DC
Output Current Ratings	5VDC	2A	2.0A	1.5A, 2.5A	2A, 3A, 6A
	12VDC	1A	1.2A, 2.5A	0.6A, 1.2A, 2.5A	0.90A, 1.4A, 2.5A, 4.3A, 8.5A, 13A
	24VDC	5A, 10A, 20A	0.65A, 1.3A, 2.5A, 3.75A, 5A, 10A	0.30A, 0.60A, 1.3A, 2.1A, 3.1A, 4.2A, 5A, 10A, 20A	0.63A, 1.1A, 2.2A, 3.2A, 4.5A
Typical Efficiency	5VDC		69%	69%	77%
	12VDC	up to 93%	75%, 78%	73% to 75%	81% to 82%
	24VDC		80% to 84%	75% to 91%	82% to 84%
Voltage Adjustments	+/-10%	+/-10% (V.ADJ control on front)			
Ripple Voltage	1.5% peak to peak max (including noise)	2% peak to peak max (including noise)		—	160mV maximum
Overvoltage Protection (input)	120%	120% or more, auto reset	120% typical	115% typical	120% typical
Overcurrent Protection (output)	105 to 120% (auto reset)	105% min shutdown	105% minimum (Zener or auto reset)		
Operating Temperature	-10° to +70°C (14° to 140°F)			-10° to +85°C	-10° to +60°C (14° to 140°F)
Termination	M3.5 phillip/slotted, spring loaded, captive (fingersafe)			M3 or M3.5	IEC Style screw terminals (fingersafe)
Approvals					

OI Touchscreens

PLCs

Automation Software

Power Supplies

Sensors

Communication

Barriers

PS6R Series Switching Power Supplies

Expandable and space-saving switching power supplies. High efficiency reduces operation costs.

Key Features:

- Plug-in output modules for additional output voltages
- Plug-in branch terminal module for additional terminals
- Power Range: 120W, 240W, 480W
- Input voltage: 100 to 240V AC (voltage range: 85 to 264V AC/110 to 350V DC)
- Up to 93% efficiency
- Up to 70°C (158°F) operating temperature
- DC low LED indicator and output contact
- The terminals are captive spring-up screws. Ring or fork terminals can be used.
- Finger-safe construction prevents electric shocks.
- Panel mount bracket and side-mount panel mounting bracket. Can be attached to a DIN rail or directly to a panel surface.
- RoHS compliant
- Meets SEMI F47 Sag Immunity



Applicable Standards	Mark	File No. or Organization
UL508 CSA C22.2 No. 107.1		UL/c-UL Listed File No. E177168
EN60950-1 EN50178 EN61204-3		TÜV SÜD EU Low Voltage Directive EMCD

ANSI (Hazardous location), and Maritime standards pending

Part Numbers

PS6R

Output Capacity*	Part No.	Input Voltage	Output Voltage	Output Current
120W	PS6R-F24	85 to 264V AC	21.6 to 26.4V	5A
240W	PS6R-G24			10A
480W	PS6R-J24			20A

*Output voltage × output current = output capacity



120W shown with Branch Terminal module attached.

Accessories

Item	Part No.	Note
Output Voltage Expansion Module Note 1	PS9Z-6RM1	Output: +5V, 2A, 10W
	PS9Z-6RM2	Output: +12V, 1A, 12W
	PS9Z-6RM3	Output: +5V, 1A/-5V, 1A, 10W
	PS9Z-6RM4	Output: +15V, 0.4A/-15V, 0.4A, 12W
	PS9Z-6RM5	Output: +5V, 1A/+12V, 0.5A, 11W
	PS9Z-6RM6	Output: +12V, 0.5A/-12V, 0.5A, 12W
Branch Terminal Module Note 2	PS9Z-6RS1	Additional screw terminals for wiring: 2 + terminals / 2 - terminals
Panel Mounting Bracket	PS9Z-6R1F	
Side-mount Panel Mounting Bracket	PS9Z-6R2F	Supplied with M3 × 6 countersunk mounting screws
DIN Rail	BNDN1000	1,000mm
DIN Rail End Clip	BNL6	

1. When using an output voltage expansion module, reduce 1A from the output current of PS6R.
2. When using a branch terminal module, the total voltage/current of PS6R and the branch terminal module should not exceed the rated current/voltage of PS6R

OT Touchscreens

PLCs

Automation Software

Power Supplies

Sensors

Communication

Barriers

Specifications

PS6R

Part No.	PS6R-F24	PS6R-G24	PS6R-J24
Input Voltage	100 to 240V AC (Voltage range: 85 to 264V AC/110 to 350V DC) (Load ≤ 80% at 85 to 100V AC, 110 to 140V DC) ^{Note 1}		
Frequency	50/60Hz		
Input Current	100V AC	1.4A typ	2.7A typ
	230V AC	0.7A typ	1.2A typ
Inrush Current	100V AC	9A max. (Ta=25°C, 100V AC cold start)	
	230V AC	20A max. (Ta=25°C, 230V AC cold start)	
Leakage Current	120V AC	0.5mA max.	
	230V AC	1mA max.	
Efficiency (Typical)	100V AC	90%	91%
	230V AC	90%	93%
Power Factor (Typical)	100V AC	0.99	0.98
	230V AC	0.96	0.97
Rated Voltage/Current	24V/5A	24V/10A	24V/20A
Adjustable Voltage Range	±10%		
Output Holding Time	20ms min. (at rated input and output)		
Start Time	800ms max. (at rated input and output)		
Rise Time	200ms max. (at rated input and output)		
Regulation	Total Fluctuation	±5% max.	
	Input Fluctuation	0.4% max.	
	Load Fluctuation	0.6% max.	
	Temperature Change	0.05%/oC max. (-10 to +60°C)	
	Ripple (including noise)	1% p-p max. (0 to +60°C) 1.5% p-p max. (-10 to 0°C)	
Supplementary Functions	Overcurrent Protection	105 to 120% (auto reset) (output current when voltage drops by 5%)	
	Overvoltage Protection	Output off at 120% ^{Note 2}	
	Operation Indicator	LED (green)	
	Voltage Low Indication	LED (amber)	
Dielectric Strength	Between input and output terminals	3000V AC, 1 minute	
	Between input and ground terminals	2000V AC, 1 minute	
	Between output and ground terminals	500V AC, 1 minute	
Insulation Resistance	100MΩ min. 500V DC megger (between input and output terminals/between input and ground terminals) (at room temperature and normal humidity)		
Operating Temperature	-10 to +70°C (no freezing) ^{Note 3}		
Operating Humidity	20 to 90% RH (no condensation)		
Storage Temperature	-25 to +75°C (no freezing)		
Storage Humidity	20 to 90% RH (no condensation)		
Vibration Resistance	10 to 55 Hz, amplitude 0.375 mm (0.187mm using PS9Z-6R1F) 2 hours each in 3 axes, 6 directions		
Shock Resistance	300 m/s ² (150 m/s ² when using a PS9Z-6R1F panel mounting bracket)		
EMC	EMI	EN61204-3 (Class B)	
	EMS	EN61204-3 (industrial)	
Degree of Protection	IP20 (IEC 60529)		
Weight (approx.)	630g	960g	1400g
Terminal Screw	M3.5 (See last page for wire sizes)		

1. DC input voltage is not subjected to safety standards.

3. See the output derating curves.

2. One minute after the output has been turned off, turn on the input again.

Easily Expandable



Output Voltage Expansion Module

In addition to the standard 24V output, additional 5, 12, and 15V outputs can be added.



Branch Terminal Module

Two terminals can be added. No wiring is required, reducing installation space.

Accessories (For use with PS6R)

Part No.	Output Voltage Expansion Module						Branch Terminal Module		
	PS9Z-6RM1	PS9Z-6RM2	PS9Z-6RM3	PS9Z-6RM4	PS9Z-6RM5	PS9Z-6RM6	PS9Z-6RS1		
Input Voltage	24V DC								
Output Capacity	10W max.	12W max.	10W max.	12W max.	11W max.	12W max.	—		
Output	Rated Voltage/Current	5V/2A	12V/1A	±5V 2A	±15V 0.4A	5V/1A, 12V/0.5A	±12V 0.5A	24V/10A max. ^{Note 1}	
	Adjustable Voltage Range	Not available							
	Voltage Accuracy	±5% max.						—	
	Start Time	200 ms max. (at rated input and output)						—	
	Regulation	Input Fluctuation	0.5% max.						—
		Load Fluctuation	1.0% max.						
		Temperature Change	0.05%/max. (-10 to +60°C)						
Ripple (including noise)		100mV max.	150mV max.	100mV max., 150mV max.					
Supplementary Functions	Overcurrent Protection	105% (auto reset)						—	
	Overvoltage Protection	Output off at 120%							
Operating Temperature	-10 to +70°C (no freezing) ^{Note 2}								
Operating Humidity	20 to 90%RH (no condensation)								
Storage Temperature	-25 to +75°C (no freezing)								
Storage Humidity	20 to 90% RH (no condensation)								
Vibration Resistance	10 to 55 Hz, amplitude 0.375 mm, 2 hours each in 3 axes, 6 directions (in combination with PS6R-J24)								
Shock Resistance	300 m/s ² (150 m/s ² when using a PS9Z-6R1F panel mounting bracket), 3 shocks each in 6 axes (in combination with PS6R-J24)								
EMC	EMI	EN61204-3 (Class B) (in combination with PS6R-□24)						—	
	EMS	EN61204-3 (industrial) (in combination with PS6R-□24)							
Safety Standards	UL508 (Listing), CSA C22.2 No.107.1, IEC/EN60950-1, EN50178 (in combination with PS6R-□24)								
Degree of Protection	IP20 (IEC 60529)								
Weight (approx.)	90g						30g		
Terminal Screw	M3.5 (See last page for wire sizes.)								

1. Ensure that the current does not exceed the rated current of the PS6R.
2. See the output derating curves.

Wide Operating Temperature Range

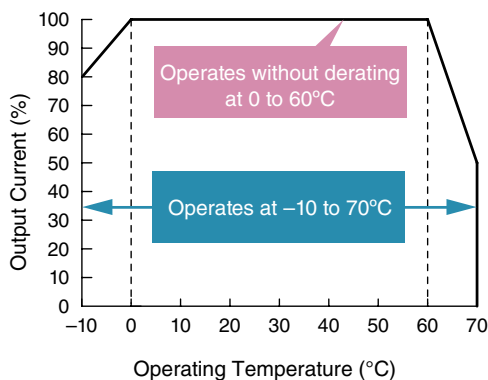

Energy-saving 93% Efficiency (480W)

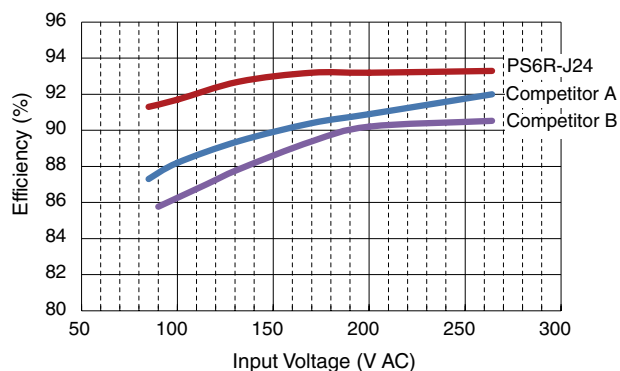

Easy Maintenance - LED Indicator

Status	Normal	Overload or Input Voltage Low*	Output short-circuit	Output OFF
DC ON (green LED)	●	●	●	●
DC Low (amber LED)	●	●	●	●

*The LEDs turn on when the input voltage drops.

Dimensions (mm)

PS6R-F24

6 - M3.5 Terminal Screws

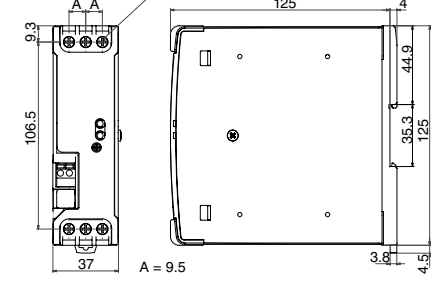

PS6R-G24

8 - M3.5 Terminal Screws

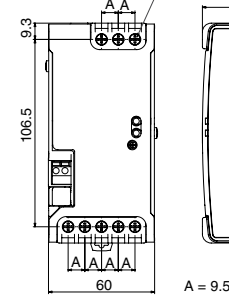

PS6R-J24

10-M3.5 Terminal Screws

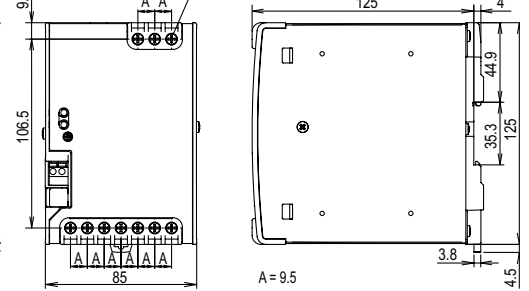

PS9Z-6R1F Panel Mounting Bracket

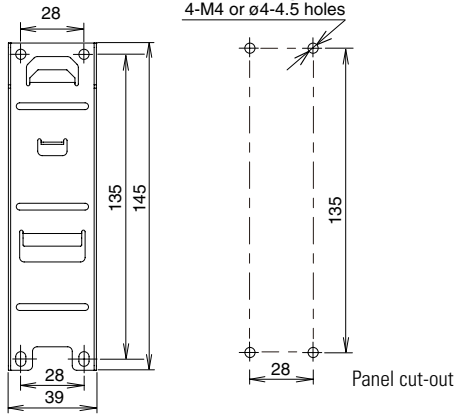

When a PS9Z-6R1F is installed on PS6R

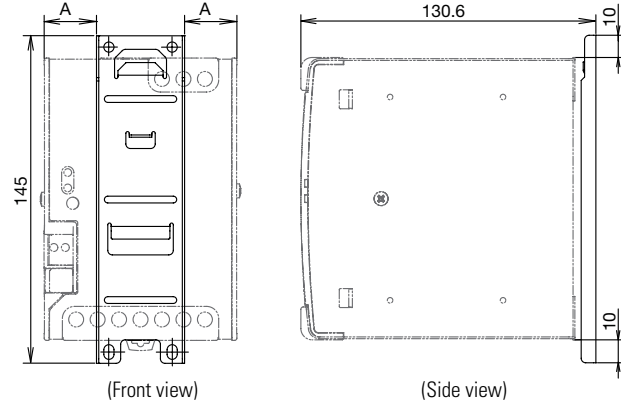

PS9Z-6R2F (Side-mount Panel Mounting Bracket)

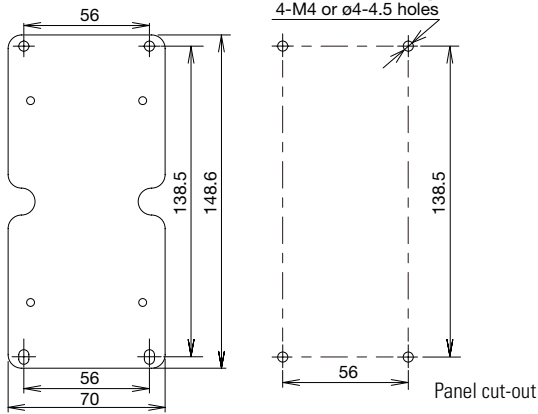

When a PS9Z-6R2F is installed on PS6R

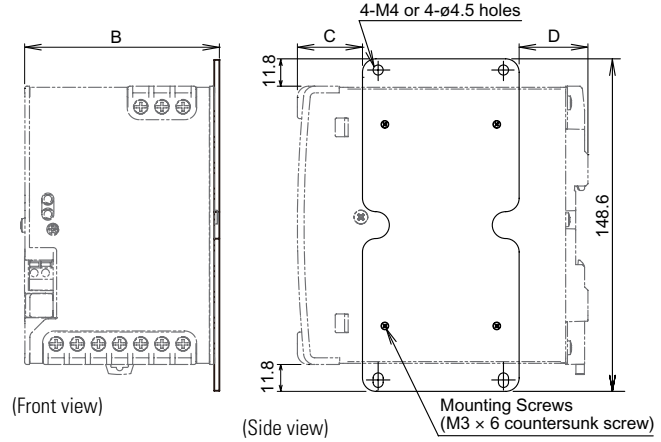

When using a PS9Z-6RM* Output Voltage Expansion Module

When using a PS9Z-6RS1 Branch Terminal Module

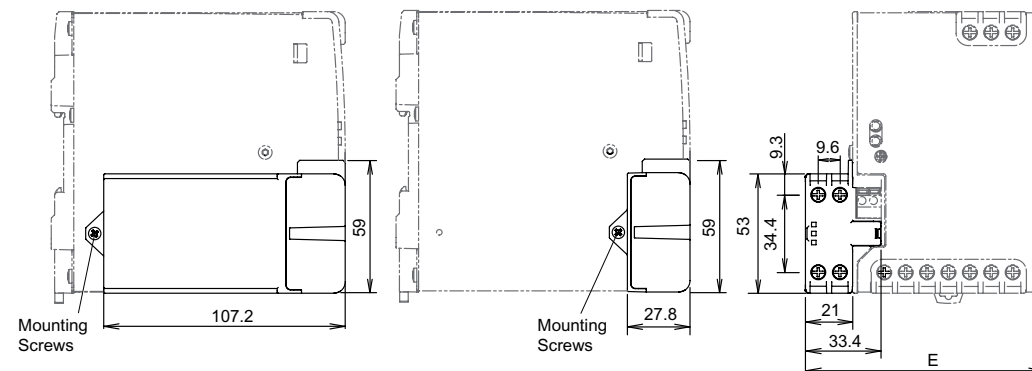

Dimension Table

	A	B	C	D	E
PS6R-F24	-	39.3	29.5	29.5	58
PS6R-G24	10.5	62.3	29.5	31	81
PS6R-J24	23	87.3	29.5	31	106

Oil Touchscreens

PLCs

Automation Software

Power Supplies

Sensors

Communication

Barriers

Operating Instructions

The PS6R should be placed in a proper enclosure. It is designed to be used with general electrical equipment and industrial electric devices

Operation Notes

1. Output interruption may indicate blown fuses. Contact IDEC.
2. The PS6R contains an internal fuse for AC input. When using DC input, install an external fuse or DC input. To avoid blown fuses, select a fuse in consideration of the rated current of the internal fuse.

Rated Current of Internal Fuses

Part No.	Internal Fuse Rated Current
PS6R-F24	4A
PS6R-G24	6.3A
PS6R-J24	10A

- Avoid overload and short-circuit for a long period of time, otherwise internal elements may be damaged.
- DC input operation is not subjected to safety standards.

Installation Notes

- The PS6R can be installed in the direction shown below only.

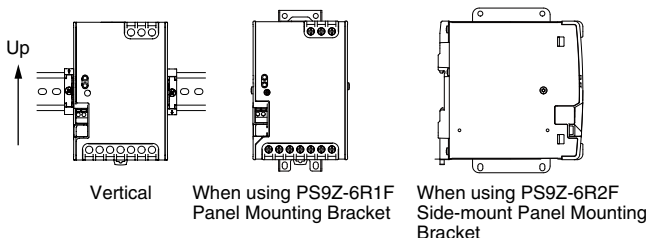

- Do not close the top and bottom openings of the PS6R to allow for heat radiation by convection.
- Maintain a minimum of 20mm clearance around the PS6R, except for the top and bottom openings.
- When derating of the output does not work, provide forced air-cooling.
- Make sure to wire the ground terminal correctly.
- For wiring, use wires with heat resistance of 60°C or higher. Use copper wire of the following sizes. Wires of the following sizes must be used to comply with UL508, CSA C22.2 No. 107.1.

Model	Terminal	Wire Size/No. of Wire	Wire Type	Torque, in-ibs (N·m)
PS6R-F24 PS6R-G24	Input	18-14 AWG, 1-wire	Copper Solid/Stranded	7.0 (0.8)
	Output	18-14 AWG, 1-wire, (18 AWG - 7A, 16 AWG - 10A, 14 AWG - 15A)		
PS6R-J24	DC OK Output	22-14 AWG, 1-wire (stripped wire length: 6 to 7mm)		
	Input	18-14 AWG, 1-wire		
	Output	18-14 AWG, 2-wire Use the same size wire for each terminal (18 AWG - 7A, 16 AWG - 10A, 14 AWG - 15A) 12 AWG, 1-wire Use with UL-listed ring/fork crimp terminal.		
PS9Z-6R□	DC OK Output	22-14 AWG, 1-wire (stripped wire length: 6 to 7mm)	Copper Solid/Stranded	—
	Output	18-14 AWG, 1-wire (18 AWG - 7A, 16 AWG - 10A, 14 AWG - 15A)	Copper Solid/Stranded	7.0 (0.8)

Applicable Crimp Terminal (reference)

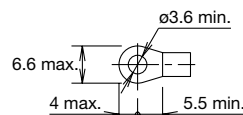

- Recommended tightening torque of the input and output terminals is 0.8N·m.
- The output voltage can be adjusted within ±10% of the rated output voltage by using the V.ADJ control. Note that overvoltage protection may work when increasing the output voltage.
- When large shocks or heavy vibrations on the PS6R are expected, the use of DIN rail or PS9Z-6R2F side-mount panel mounting bracket is recommended.

Series Operation

The following series operation is allowed. Connect Schottky barrier diodes as shown below. Output voltage expansion modules cannot be connected in series.

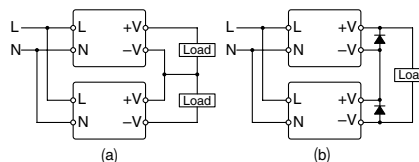

Select a Schottky diode in consideration of the rated current. The diode's reverse voltage must be higher than the PS6R's output voltage.

Parallel Operation

Parallel operation is possible to increase the output capacity. Output voltage expansion modules cannot be connected in series.

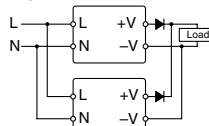

When increasing the capacity, observe the following.

1. Maintain the operating temperature below 40°C.
2. Output cannot be connected directly in parallel operation. Connect a diode to the output of each PS6R.
3. Output terminal voltage of both power supplies must be the same. Also, maintain the voltage difference between the power supplies below 30mV.
4. Use load lines of the same diameter and length.
5. Set the output voltage higher for the amount of diode forward voltage drop.
6. Turn on the inputs at the same time.
7. Select a diode in consideration of:
 - Diode's reverse voltage must be higher than the PS6R's output voltage.
 - Diode's current must be three times the PS6R's output current. Provide a heat sink for heat dissipation.

Parts Description

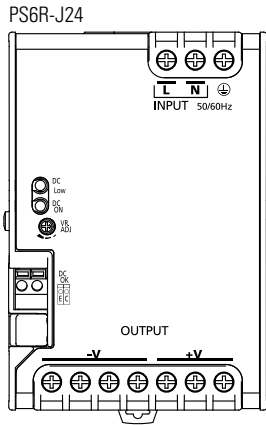

PS6R-6RM1/M2/M3
Output Voltage Expansion Module

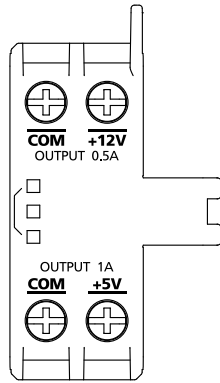

PS9Z-6RM3/M4/M6
Output Voltage Expansion Module

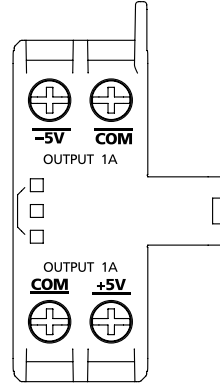

PS6R-6RS1
Branch Terminal Module

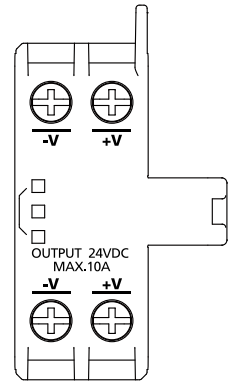

(PS6R-6RM5 shown)

PS6R-□24/PS9Z-6RS1

Marking	Name	Description
L, N	Input Terminal	Voltage range: 85 to 264V AC/110 to 350V DC
⊕	Ground Terminal	Be sure to connect this terminal to a proper ground.
+V, -V	DC Output Terminals	+V: Positive output terminal -V: Negative output terminal
VR.ADJ	Output Voltage Adjustment	Allows adjustment within ±10%. Turning clockwise increases the output voltage.
DC ON	Operation Indicator (green)	Lights on when the output voltage is on.
DC LOW	Output Low Indicator (Amber)	Lights on when the output voltage drops approximately 80% of the rated value.
DC OK	DC OK Output	Lights on when the output voltage is more than 80% of the rated value. NPN transistor output (50V DC max., 50 mA max.)

PS9Z-6RM□

Marking	Name	Description
+5V, +12V, +15V	DC Output Terminal	+5V side, +12V side, +15V side
-5V, -12V, -15V	DC Output Terminal	-5V side, -12V side, -15V side
COM	DC Output Terminal	0V side (wired internally to -V of PR6R-J24)

Characteristics

Operating Temperature vs. Output Current (Derating Curves)

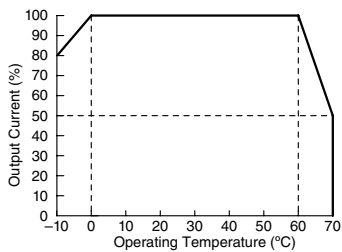

Output Current vs. Input Voltage (Derating Curves) (Ta=25°C)

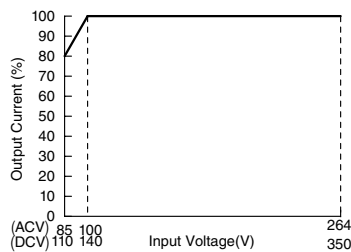

Overcurrent Protection Characteristics PS6R-□24

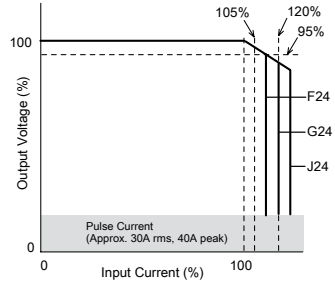

Overcurrent Protection Characteristics PS9Z-6RM*

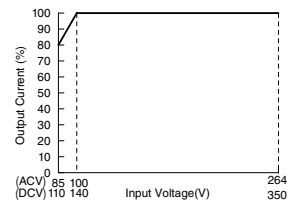

Operating Temperature approved by Safety Standards

Part No.	UL508, CSA C22.2 No. 107. 1	EN60950-1, EN50178
PS6R-F24	60°C	60°C
PS6R-G24	60°C	60°C
PS6R-J24	55°C	60°C
PS9Z-6RM□□	55°C	60°C

**PS5R Slim Line Series
Switching Power Supplies**

Key features:

- Lightweight and compact in size
- Wide power range: 10W-240W
- Universal input:
10W to 90W: 85-264V AC/100-370V DC
120W and 240W: 85-264V AC/100-350V DC
- Power Factor Correction for 60W to 240W (EN61000-3-2)
- Meets SEMI F47 Sag Immunity (120W & 240W only)
- UL Listed for Class 1, Div. 2 Hazardous Locations
- Overcurrent protection, auto-reset
- Overvoltage protection, shut down
- Spring-up screw terminal type, IP20
- DIN rail or panel surface mount
- Approvals:
CE Marked
TÜV
c-UL, UL508
UL1310 (PS5R-SB, -SC, -SD)

ANSI/ISA-12.12.01-2011 (Hazardous locations)
EN50178:1997
LVD: EN60950:2000
EMC: Directive EN61204-3:2000 (EMI: Class B, EMS: Industrial)



(SEMI F47 120W & 240W only)

Designed with Accessibility & Convenience in Mind!

DC Low Indicator (15W, 120W & 240W Slim Line Only)

The indicator turns on when the output voltage drops below 80% of the rated value. This assists in troubleshooting power supply problems.

DC ON Indicator

The indicator turns on when the unit is powered up. This is a convenient way to know when the power supply is receiving power.

Output Voltage Adjustment

The output voltage can be easily adjusted within $\pm 10\%$ of the rated voltage.



Fingersafe, Spring-up Screw Terminals

Don't worry about losing screws or getting an inadvertent shock from a terminal. The terminals are captive spring-up screws, which makes using them as easy as pushing a screw down and tightening it. They are shock and vibration resistant, and work with ring lugs, fork connectors or stripped wire connections. The terminals are rated IP20 (when tightened) meaning they are recessed to keep fingers and objects from touching the input contacts.

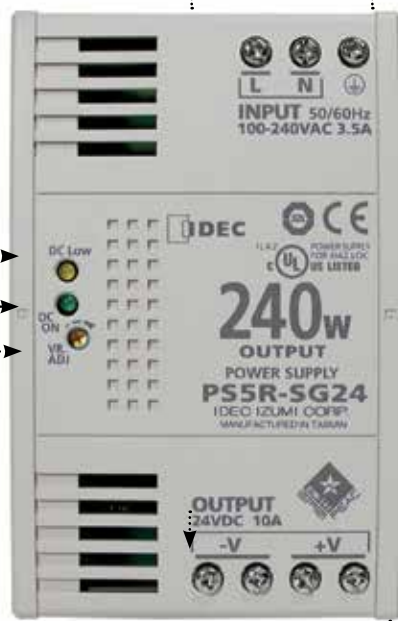

Universal Input Power

The applied input power has a range of 85-264V AC (100-350V DC) without the use of jumpers or slide switches. This makes IDEC power supplies suitable for use anywhere in the world.

Long Life Expectancy

IDEC power supplies are very reliable, with a life expectancy of 70,000 hrs. (minimum) or longer, depending on usage. Power factor correction has also been included to minimize harmonic distortion, resulting in a longer operating life and increased reliability.

Output Channel

With very low output ripples of less than 1% peak to peak, the 120W and 240W power supplies are some of the best in the industry. The output comes with overload protection that avoids damaging the power supply and the spring-up, fingersafe, screw terminals add a level of safety and ease for the user. The 240W power supply also has the convenience of two output terminals.

Top View



Ventilation Grill

Provides cooling for the power supply and prevents small objects from falling into the power supply circuitry.



OT Touchscreens

PLCs

Automation Software

Power Supplies

Sensors

Communication

Barriers

Part Numbers

01 Touchscreens

PLCs





Automation Software

Power Supplies

Sensors

Communication

Barriers

Style	Output Capacity	Input Voltage	Output Voltage	Rated Current	Part Number	Style	Output Capacity	Input Voltage	Output Voltage	Rated Current	Part Number
	10	85 to 264V AC	5V DC	2.0A	PS5R-SB05		90	85 to 264V AC	24V DC	3.75A	PS5R-SE24
	15		12V DC	1.2A	PS5R-SB12				24V DC	5A	PS5R-SF24
			24V DC	0.65A	PS5R-SB24						
	30	12V DC	2.5A	PS5R-SC12		120	85 to 264V AC	24V DC	5A	PS5R-SF24	
		24V DC	1.3A	PS5R-SC24							
	60	85 to 264V AC	24V DC	2.5A	PS5R-SD24		240	85 to 264V AC	24V DC	10A	PS5R-SG24

Accessories

Appearance	Description	Part Number
	Panel Mounting Bracket for PS5R-SB	PS9Z-5R1B
	Panel Mounting Bracket for PS5R-SB (flat side mounting)	PS9Z-5R2B
	Panel Mounting Bracket for PS5R-SC and PS5R-SD	PS9Z-5R1C
	Panel Mounting Bracket for PS5R-SE	PS9Z-5R1E
	Panel Mounting Bracket for PS5R-SF & PS5R-SG	PS9Z-5R1G
	DIN rail (1000mm)	BNDN1000
	DIN rail end clip	BNL5

Specifications

Model	5V DC output	PS5R-SB05	–	–	–	–	–	
	12V DC output	PS5R-SB12	PS5R-SC12	–	–	–	–	
	24V DC output	PS5R-SB24	PS5R-SC24	PS5R-SD24	PS5R-SE24	PS5R-SF24	PS5R-SG24	
Output Capacity		15W (5V Model is 10W)	30W	60W	90W	120W	240W	
Input	Input Voltage (single-phase, 2-wire)		85 to 264V AC, 100 to 370V DC			85 to 264V AC, 100 to 350V DC		
	Input Current (maximum)	100VAC	0.45A	0.9A	1.7A	2.3A	1.8A	3.5A
		200VAC	0.3A	0.6A	1.0A	1.4A	1.0A	1.7A
	Internal Fuse Rating		2A	3.15A		4A		6.3A
	Inrush Current (cold start)		50A maximum (at 200V AC)					
	Leakage Current (at no load)		132V AC: 0.38 mA maximum 264V AC: 0.75 mA maximum	0.75mA maximum			1mA maximum	
	Typical Efficiency	5V DC	69%	–	–	–	–	–
12V DC		75%	78%	–	–	–	–	
24V DC		79%	80%	83%	82%	84%		
Output Current Ratings	5V DC	2.0A	–	–	–	–	–	
	12V DC	1.2A	2.5A	–	–	–	–	
	24V DC	0.65A	1.3A	2.5A	3.75A	5A	10A	
Voltage Adjustment		±10% (V. ADJ control on front)						
Output Holding Time		20ms minimum (at rated input and output)						
Starting Time		200ms maximum	–	–	–	650ms maximum	500ms maximum	
Rise Time		100ms maximum (at rated input and output)				200ms maximum		
Line Regulation		0.4% maximum						
Load Regulation		1.5% maximum					0.8% max	
Temperature Regulation		0.05% degree C maximum						
Ripple Voltage		2% peak to peak maximum (including noise)				1% peak to peak maximum (including noise)		
Overcurrent Protection		105% or more, auto reset			105 to 130%, auto reset		103 to 110%, auto reset	
Overvoltage Protection		120% min. SHUTDOWN						
Operation Indicator		LED (green)						
Voltage Low Indication		LED (amber)	–	–	–	LED (amber)		
Dielectric Strength		Between Input and Ground: 2000 V AC, 1 minute Between input and output: 3000V AC, 1 minute; Between output and ground: 500V AC, 1 minute.						
Insulation Resistance		Between Input & Output Terminals: 100 MΩ Min						
Operating Temperature		–10 to +65°C (14 to 149°F)	–10 to 60°C (14 to 140°F)					
Storage Temperature		–25 to 75°C (–13 to +167°F)						
Operating Humidity		20 to 90% relative humidity (no condensation)						
Vibration Resistance		Frequency 10 to 55Hz, Amplitude 0.375mm						
Shock Resistance		300m/s ² (30G) 3 times each in 6 axes						
Approvals		EMC: EN61204-3 (EMI: Class B, EMS: Industrial), c-UL (CSA 22.2 No. 14), ANSI/ISA-12.12.01-2011, UL508, LVD: EN60950, EN50178 UL1310 Class 2, c-UL (CSA 22.2 No. 213 and 223)						
Harmonic Directive		N/A			EN61000-3-2 A14 class A			
Weight (approx.)		160g	250g	285g	440g	630g	1000g	
Terminal Screw		M3.5 slotted-Phillips head screw (screw terminal type)						
IP protection		IP20 fingersafe						
Dimensions H x W x D (mm)		90 x 22.5 x 95	95 x 36 x 108	115 x 46 x 121	115 x 50 x 129	125 x 80 x 149.5		
Dimensions H x W x D (inches)		3.54 x 0.89 x 3.74	3.74 x 1.42 x 4.25	4.53 x 1.81 x 4.76	4.53 x 1.97 x 5.08	4.92 x 3.15 x 5.89		

1. For dimensions, see page 161.



OT Touchscreens

PLCs

Automation Software

Power Supplies

Sensors

Communication

Barriers

Temperature Derating Curves

All IDEC Slim Line power supplies are listed to UL508, which allows operation at 100% capacity inside a panel. This eliminates the need to use oversize power supplies or utilize two power supplies derated at 50% of their rated output.

The charts below show that the PS5R Slim 10W (at 60°C) and 15W (at 60°C), 30W/60W/90W (at 55°C), 120W (at 40°C), and 240W (at 45°C) meet the elevated, operating temperature required by UL508 and EN60950 standards to operate at an output current of 100%. The output current starts to derate beyond the required temperature.

PS5R-SB

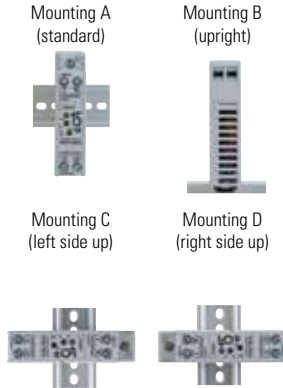
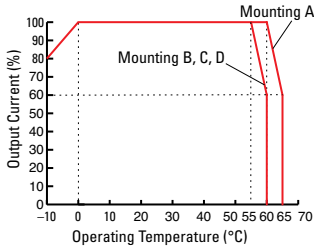

PS5R-SC

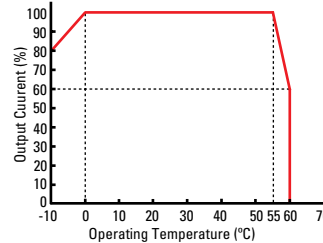

PS5R-SG

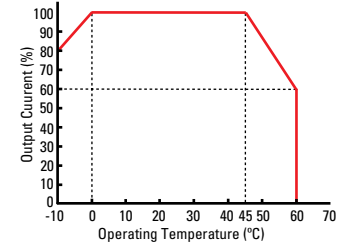

Derating curve for PS5R-SB varies depending on mounting method (see right).

PS5R-SD, -SE, -SF

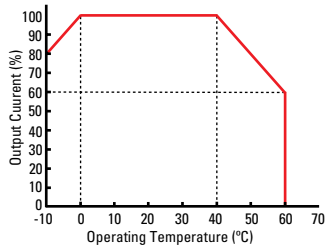

PS5R-SE 90W/3.75A/24V DC versus a Leading Competitor

Standard derating curve (operating temperature vs. output current)

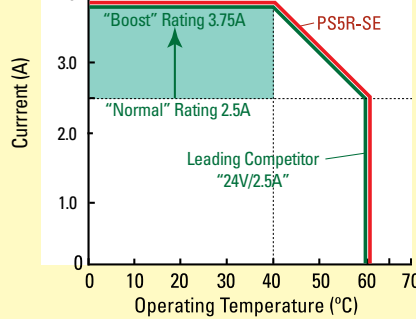

Don't Believe the Hype

Other companies use slick marketing to sell you 60W power supplies with a "BOOST," but what they don't tell you is that these are merely 90W power supplies that have been renamed to fool you into thinking they have a unique feature. IDEC 90W power supplies are just what they claim, 90W power supplies. The truth is IDEC led the market by incorporating UL508 DIN rail mount power supplies as a standard product. Don't let the other guys pull a fast one on you by claiming to provide features that just aren't true, or even possible. See what IDEC has to offer, no strings attached.

Overload Protection

Overload protection prevents the power supply from being damaged when an overload occurs. There are two kinds of protection.

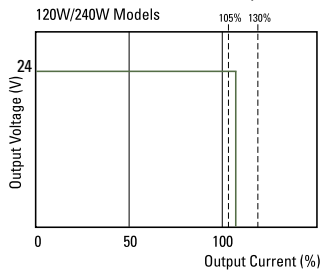

Overcurrent Protection

When the output current exceeds 105% of the rated current, overload protection is triggered, and the output voltage starts decreasing. When the output current returns within the rated range, the overload protection function is automatically cleared.

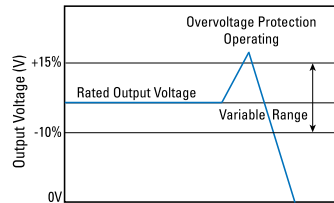

Overvoltage Protection

When the output voltage of the power supply rises to 120% or more of the rated value, the output will shut off. To restore power, only manual reset is available which is an advantage in troubleshooting.

Overcurrent Protection PS5R-SF, -SG

Overvoltage Protection

SEMI-F47 Approved

The SEMI F47 (Semiconductor Processing Equipment Voltage Sag Immunity) defines the minimum voltage sag ride-through requirements for semiconductor processing, automated test equipment and other equipment. It requires that the equipment be able to tolerate voltage sags on an AC power line without interrupting operations. This avoids the loss of production and money.

The graph shows how the equipment must tolerate sags to 50% for 200ms, sags to 70% for up to 0.5 seconds and sags to 80% for up to 1 second.

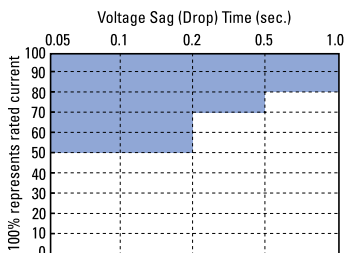

Voltage Sag Sliding Scale PS5R-SF, -SG

01 Touchscreens

PLCs

Automation Software

Power Supplies

Sensors

Communication

Barriers

Dimensions and Terminal Markings

PS5R-SB

Height 90mm
Width 22.5mm
Depth 95mm

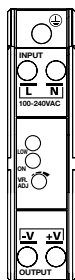

PS5R-SC
PS5R-SD

Height 95.0mm
Width 36.0mm
Depth 108.0mm

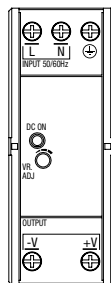

PS5R-SE

Height 115.0mm
Width 46.0mm
Depth 121.0mm

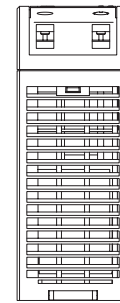
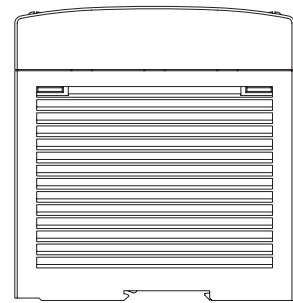
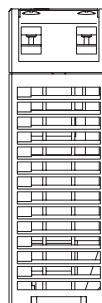
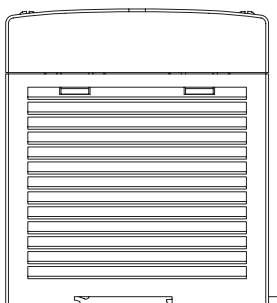
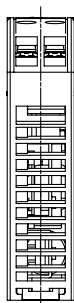
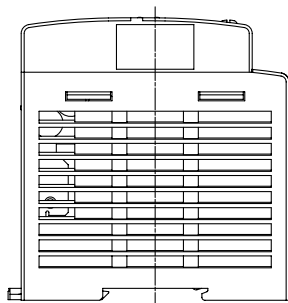
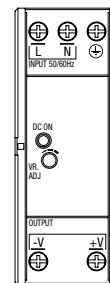

PS5R-SF

Height 115.0mm
Width 50.0mm
Depth 129.0mm

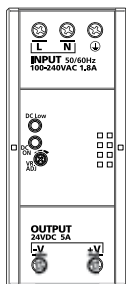

PS5R-SG

Height 125.0 mm
Width 80.0 mm
Depth 149.5 mm

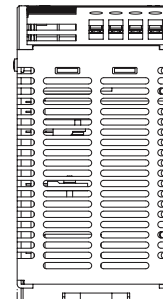
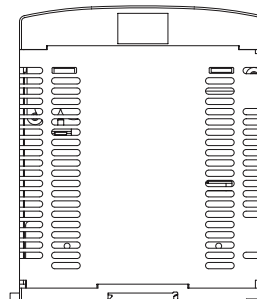
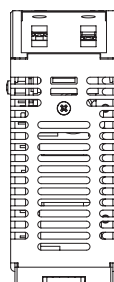
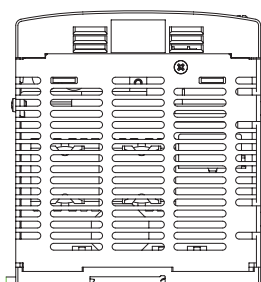
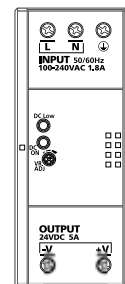

Front Panel (terminals)

Markings	Name	Description
V. ADJ	Voltage adjustment	Adjusts within ±10%; turn clockwise to increase output voltage.
DC ON	Operation indicator	Green LED is lit when output voltage is on.
DC Low	Output indicator	Amber LED is lit when output voltage drops below 80% of rated voltage.
+V, -V	DC output terminals	+V: Positive output Terminal -V: Negative output terminal
⊕	Frame ground	Ground this terminal to reduce high-frequency noise caused by switching power supply.
L, N	Input terminals	Accept a wide range of voltages and frequencies (no polarity at DC input).

OT Touchscreens

PLCs

Automation Software

Power Supplies

Sensors

Communication

Barriers

Mounting Bracket Dimensions (mm)

PS9Z-5R1B (for PS5R-SB)

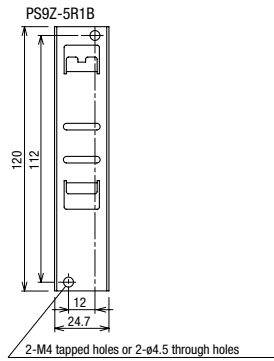

PS9Z-5R2B (for PS5R-SB)

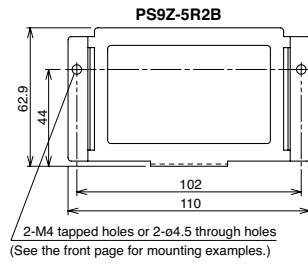

PS9Z-5R1C (for PS5R-SC & PS5R-SD)

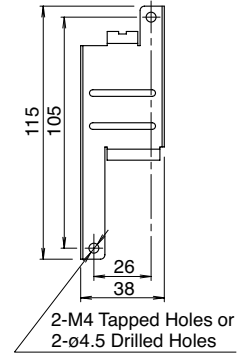

PS9Z-5R1E (for PS5R-SE)

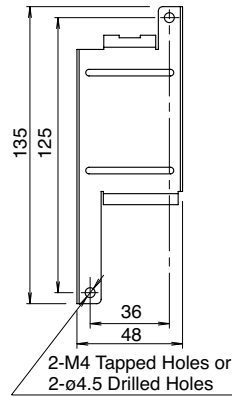

PS9Z-5R1G (for PS5R-SF & PS5R-SG)

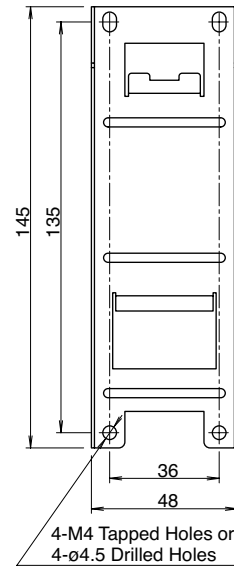

0I Touchscreens

PLCs

Automation Software

Power Supplies

Sensors

Communication

Barriers

**PS5R Standard Series
Switching Power Supplies**

Key features:

- Wide power range: 7.5W-480W
- Universal input :
7.5W-50W: 85-264V AC/105-370V DC
100W: 85-132V AC/170-264V AC
240-370V DC (selectable)
75W, 120W, 240W: 85-264V AC/110-350V DC
480W: 3 phase: 320- 575V AC
3 phase: 360- 575V AC
- Overcurrent/overvoltage protection
- Power Factor Correction (75W, 120W, 240W models)
EN61000-3-3
EN61000-3-2
- Voltage adjustment +10%
- Spring-up crew terminal, IP20 (finger-safe)
- DIN rail or panel surface mount
- Approvals:
CE marked
UL 508 Listed
c-UL
TÜV approved
LVD EN60950:2000

EMC Directives:
EN50081-2
EN50082-2
EN61000-6-2



Part Numbers

Style	Output Capacity	Input Voltage	Output Voltage	Rated Current	Part Number	Style	Output Capacity	Input Voltage	Output Voltage	Rated Current	Part Number
	7.5	85 to 264V AC	5V DC	1.5A	PS5R-A05		75	85 to 264V AC	24V DC	3.1A	PS5R-Q24
			12V DC	0.6A	PS5R-A12				24V DC	4.2A	PS5R-E24
			24V DC	0.3A	PS5R-A24				24V DC	5A	PS5R-F24
	15	85 to 264V AC	5V DC	2.5A	PS5R-B05		100	100 to 240V AC	24V DC	10A	PS5R-G24
			12V DC	1.2A	PS5R-B12				24V DC	20A	PS5R-TJ24*
	30	85 to 264V AC	12V DC	2.5A	PS5R-C12		120	100 to 240V AC	24V DC	10A	PS5R-G24
			24V DC	1.3A	PS5R-C24				24V DC	20A	PS5R-TJ24*
	50	85 to 264V AC	24V DC	2.1A	PS5R-D24		240	100 to 240V AC	24V DC	10A	PS5R-G24
			24V DC	2.1A	PS5R-D24				24V DC	20A	PS5R-TJ24*
	480	320 to 575V AC (3 phase)	24V DC	20A	PS5R-TJ24*		480	360 to 575V AC (2 phase)	24V DC	20A	PS5R-TJ24*
		360 to 575V AC (2 phase)	24V DC	20A	PS5R-TJ24*			24V DC	20A	PS5R-TJ24*	

* 3-Phase

Specifications

Model	PS5R-A05	PS5R-B05*	—	—	—	—	—	—	—		
	PS5R-A12	PS5R-B12	PS5R-C12	—	—	—	—	—	—		
	PS5R-A24	PS5R-B24	PS5R-C24	PS5R-D24	PS5R-Q24	PS5R-E24	PS5R-F24	PS5R-G24	PS5R-TJ24		
Output Capacity	7.5W	15W	30W	50W	75W	100W	120W	240W	480W		
Input	Input Voltage (single-phase, 2-wire) 100 to 240V AC nominal (85 to 264V AC), 50/60Hz (47 to 63Hz) 110 to 340V DC nominal (105 to 370V DC)										
	Input Current (typical)	0.17A at 100V AC	0.3A at 100V AC	0.68A at 100V AC	1.15A at 100V AC	1.1A at 100V AC	2.5A at 100V AC 1.5A at 200V AC	1.8A at 100V AC	4A at 100V AC	3 x 1.1A 3 x 0.8A	
	Internal Fuse Rating	2A	2A	3.15A	3.15A	3.15A	4A	4A	6.3A		
	Inrush Current	50A maximum (at cold start at 200V AC)					70A maximum (at cold start at 230V AC)	50A maximum (at cold start at 200V AC)	70A maximum (at cold start at 230V AC)		21A na
	Leakage Current (at no load)	0.75mA maximum (60Hz, measured in conformance with UL, CSA, VDE)								<3.5ml	
	Typical Efficiency	69% at 5V 75% at 12V 79% at 24V		75% at 12V 75% at 24V	79% at 24V	83% at 24V	85% at 24V	83% at 24V		91%	
	Overvoltage Protection	Outputs turns off at 105% (typical)									
Output	Voltage and Current Ratings 5V, 1.5A 12V, 0.6A 24V, 0.3A										
	Voltage Adjustments ±10% (V.ADJ screw on top)										
	Output Holding Time 20ms minimum (at full rated input and output)										
	Rise Time 200ms maximum (at full rated input and output)										
	Line Regulation 0.4% maximum										
	Load Regulation 1.5% maximum										
	Fluctuation due to Ambient Temperature Change 0.05% maximum										
	Ripple Voltage 2% peak to peak maximum (including noise)										
Overload Protection 120% typical (Zener-limiting)											
Operation Indicator	LED (green)										
Parallel Operation Allowed	PS5R-A	PS5R-B	PS5R-C	PS5R-D	PS5R-Q	PS5R-E	PS5R-F	PS5R-G			
Dielectric Strength	No										
Insulation Resistance	Between input and output terminals: 3,000V AC, 1 minute Between input terminals and housing: 2,000V AC, 1 minute Between output terminal and housing: 500V AC, 1 minute										
Operating Temperature	-10° to +60°C (14° to 140°F) (see derating curves)										
Storage Temperature	-30° to +85°C (-22° to 185°F)										
Operating Humidity	20 to 90% relative humidity (no condensation)										
Vibration Resistance	45m/s ² , 10 to 55Hz, 2 hours on each of 3 axes					10 to 50Hz, 0.75mm p-p, 2 hrs on each of 3 axes					
Shock Resistance	300m/s ² (30G), 3 shocks in each of 6 directions										
Approvals	Conforms to EMC Directives EN50081-2 & EN50082-2. LVD Directive EN60529 — Certified to EN60950. UL508 listed. c-UL, TUV approved. CE marked. EN61000-3-2										
Weight	150g	170g	360g	390g	800g	600g	1200g	2000g	2000g		
Termination	Spring-up, fingersafe terminals with captive M3.5 screws										
IP protection	IP20 (finger safe)										
Dimensions H x W x D (mm)	75 x 45 x 70	75 x 45 x 95	75 x 90 x 95	75 x 90 x 95	120 x 85 x 140	75 x 145 x 95	120 x 115 x 140	120 x 200 x 140	130 x 115 x 152.5		
Dimensions H x W x D (inches)	2.95 x 1.77 x 2.76	2.95 x 1.77 x 3.74	2.95 x 3.54 x 3.74	2.95 x 3.54 x 3.74	4.72 x 3.35 x 5.52	2.95 x 5.71 x 3.74	4.72 x 4.53 x 5.52	4.72 x 7.87 x 5.51	5.12 x 4.53 x 6.00		

1. For dimensions, see page 167.
2. For usage instructions, see page 166.

3. *12.5W for 5VDC model.



Temperature Derating Curves

PS5R-A/B

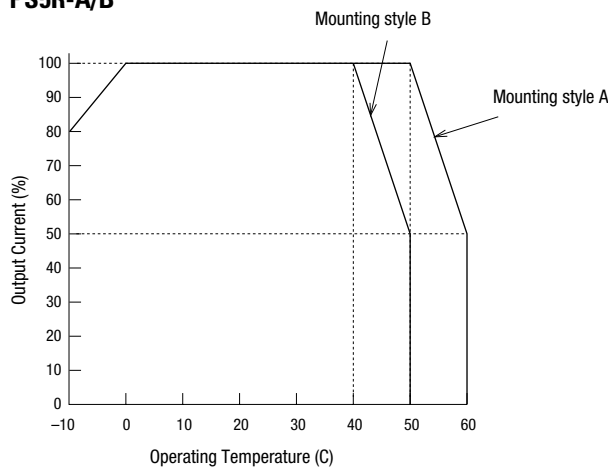

PS5R-C/D

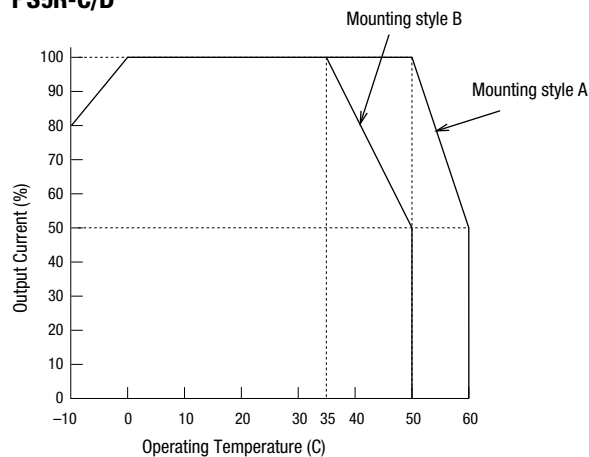

PS5R-E

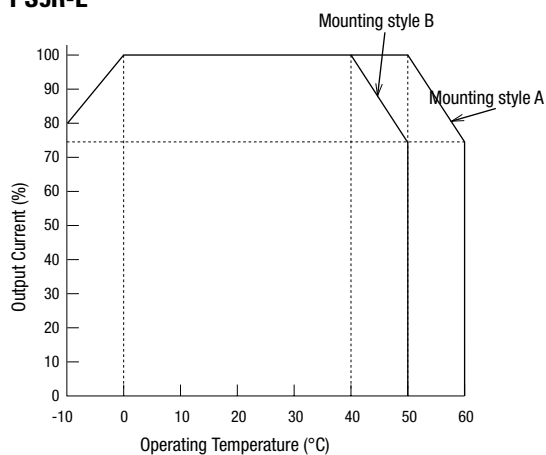

PS5R-Q

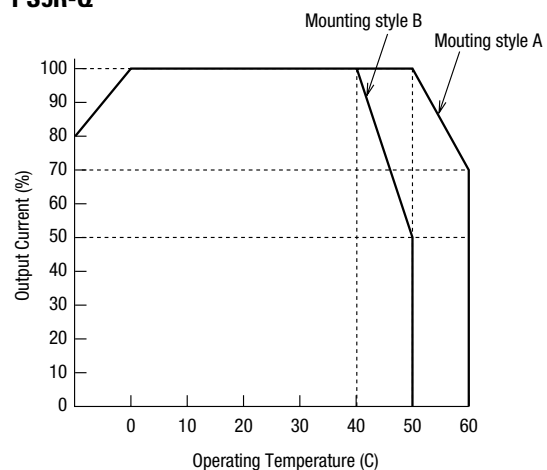

PS5R-F/G

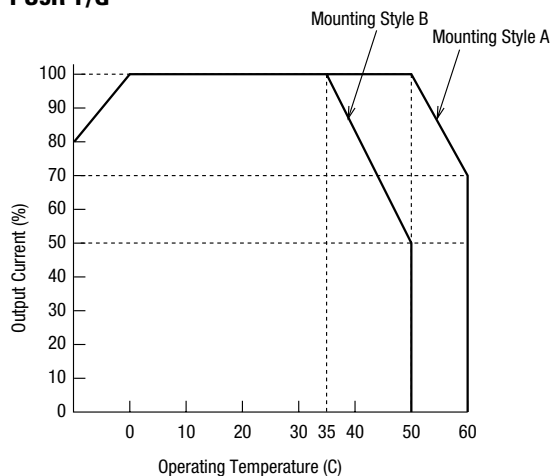

PS5R-TJ

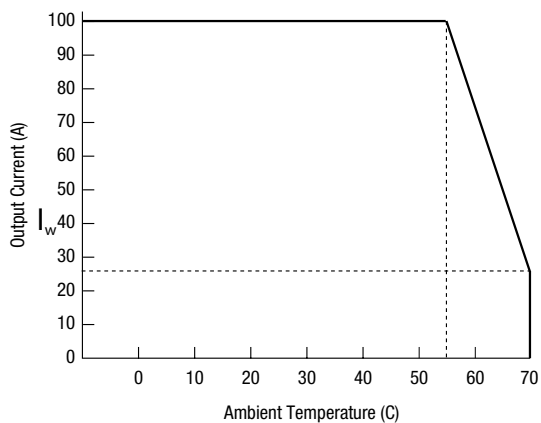

A Mounting (standard)

B Mounting (Facing Upward)

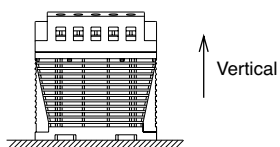
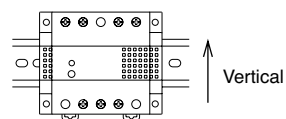

Accessories

Part Numbers: PS5R Accessories

Appearance	Description	Part Number
	DIN rail (1000mm)	BNDN1000
	DIN rail end clip	BNL5

Installation Instructions

Time-Saving Spring-up Terminals

The innovative terminals on the PS5R series use a spring-loaded screw. This makes installation as easy as pushing down and turning with a screwdriver. Installation time is cut in half since the screws do not need to be backed out to install wiring. The screws are held captive once installed and are 100% finger-safe. Screw terminals accept bare wire or ring or fork connectors.

1. Insert the wire connector into the slot on the side of the power supply.



2. Using a flat head or Phillips screwdriver, push down and turn the screw.

The wire is now connected, and the screw terminal is fingersafe!

Front Panel (terminals)

Markings	Name	Description
V. ADJ	Voltage adjustment	Adjusts within $\pm 10\%$; turn clockwise to increase output voltage
DC ON	Operation indicator	Green LED is lit when output voltage is on
+V, -V	DC output terminals	+V: Positive output Terminal -V: Negative output terminal
	Frame ground	Ground this terminal to reduce high-frequency currents caused by switching
L, N	Input terminals	Accept a wide range of voltages and frequencies (no polarity at DC input)
NC	No connection	Do not insert wires here, as this may damage the power supply

Overcurrent Protection Characteristics

PS5R-A/B

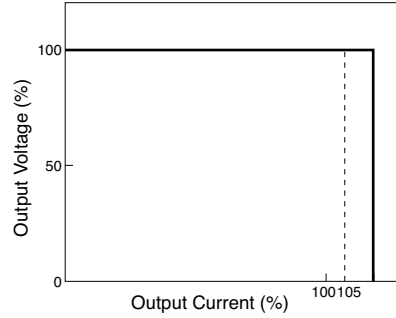

PS5R-C/D/E

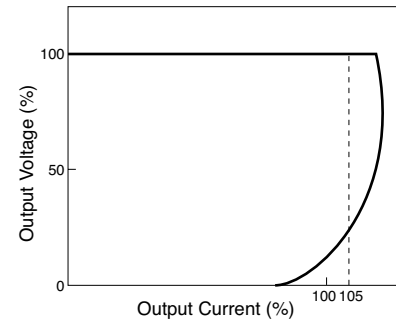

Parallel Operation

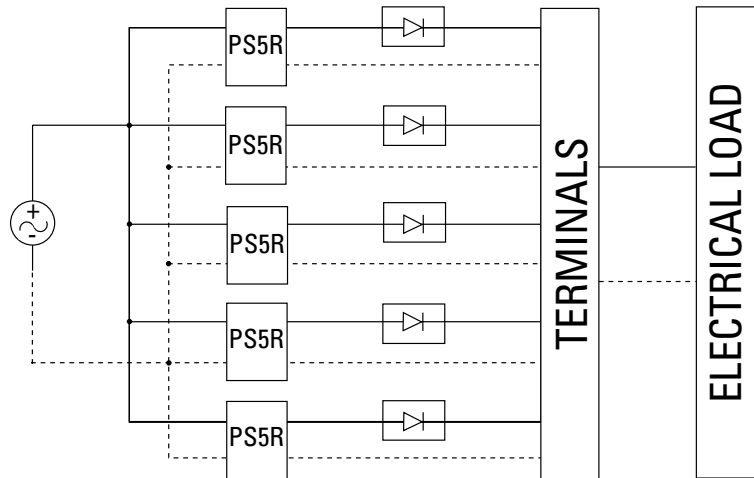

1. Parallel operation only recommended for PS5R-Q24, PS5R-F24 and PS5R-G24.
2. Factory recommended diode ST Microelectronics BYV54V-50, BYV54V-100, BYV54V-200, BYV541V-200 or with equivalent electrical specifications.
3. Using the voltage adjustment make sure out-voltage is the same for all power supplies.

Dimensions

PS5R-A (7.5W)

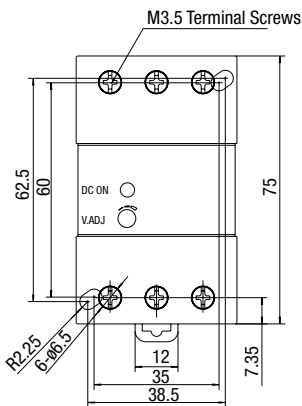

PS5R-B (15W)

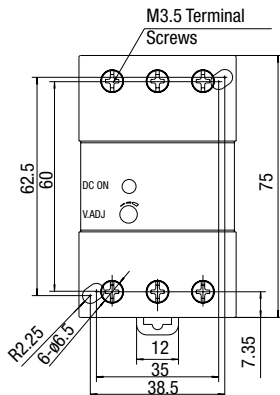

PS5R-C (30W)

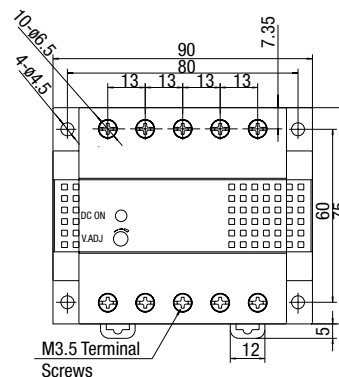

PS5R-D (50W)

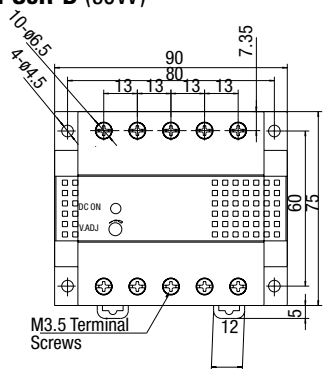

PS5R-Q (75W)

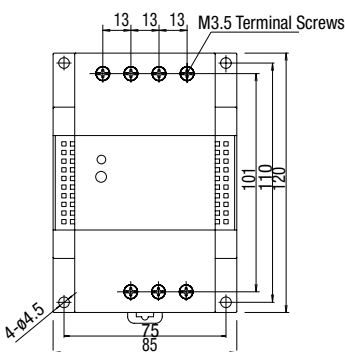

PS5R-F (120W)

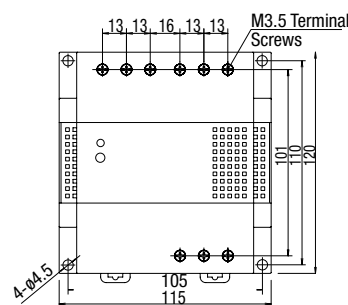

PS5R-E (100W)

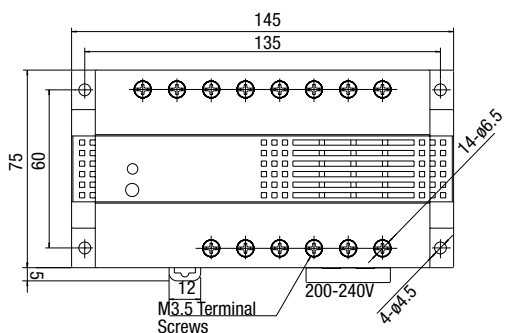

PS5R-G (240W)

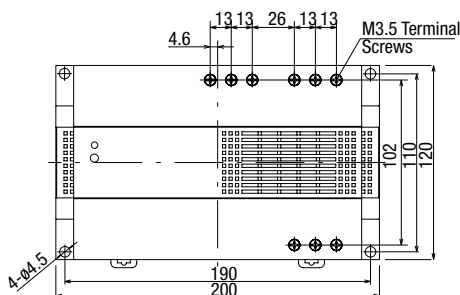

PS5R-TJ24

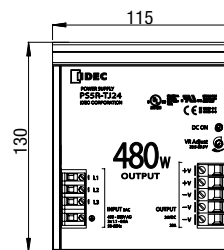

Terminal Markings

PS5R-A/B

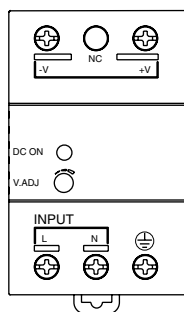

PS5R-C/D/Q/F/G

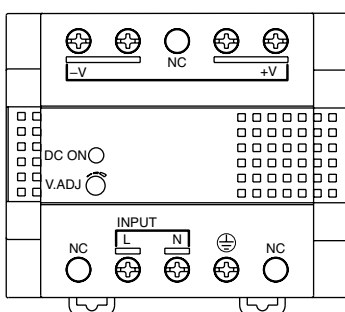

PS5R-E

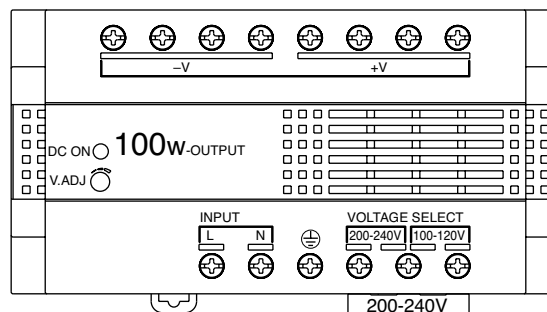

PS3X Series

Key features:

- Compact size
- Universal AC input voltage
- 5V, 12V and 24V DC outputs
- Available with mounting brackets for direct or DIN rail mounting
- Overcurrent/overvoltage protection
- EMC, EN55022 Class B compliant
- UL/c-UL recognized, TUV



Part Numbers

Power Supply

Style	Output Capacity	Part Number	Input Voltage	Output Voltage	Output Current
	15W	PS3X-B05AFC	100 to 240V AC	5V	3.0A
		PS3X-B12AFC		12V	1.3A
		PS3X-B24AFC		24V	0.63A
	25W	PS3X-C05AFC		5V	5.0A
		PS3X-C12AFC		12V	2.1A
		PS3X-C24AFC		24V	1.1A
	50W	PS3X-D12AFG		12V	4.2A
		PS3X-D24AFG		24V	2.2A
	75W	PS3X-Q05AFG		5V	12.0A
		PS3X-Q12AFG		12V	6.0A
		PS3X-Q24AFG		24V	3.2A
	100W	PS3X-E05AFG		5V	16.0A
		PS3X-E12AFG		12V	8.5A
		PS3X-E24AFG		24V	4.5A

L-shaped Mounting Bracket (optional)

Applicable Power Supply	Part Number
PS3X-B	PS9Z-3N3A
PS3X-C	PS9Z-3N3B
PS3X-D	PS9Z-3E3B
PS3X-Q	PS9Z-3N3E
PS3X-E	

DIN-rail Mounting Bracket (optional)

Applicable Power Supply	Part Number
PS3X-B	PS9Z-3N4B
PS3X-C	
PS3X-D	PS9Z-3E4C
PS3X-Q	PS9Z-3E4D
PS3X-E	

DIN Rail

Appearance	Part Number	Length	Material	Weight (g)
	BNDN1000	1000mm	Aluminum	200

End Clips

Appearance	Part Number	Description
	BNL5	small DIN rail end clip
	BNL6	medium DIN rail end clip (the BNL6 has a higher profile than BNL5)

Part Number Configuration

PS3X - B 05 AF C

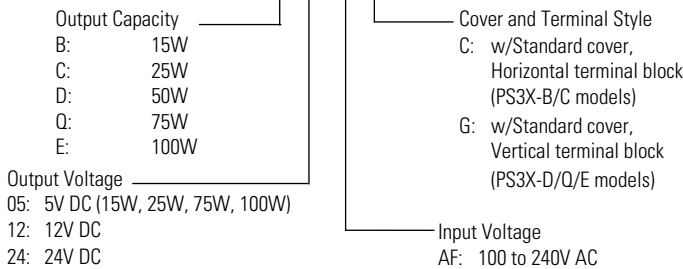

Specifications

Model		[15W] PS3X-B05/B12/B24	[25W] PS3X-C05/C12/C24	[50W] PS3X-D12/D24	[75W] PS3X-Q05/Q12/Q24	[100W] PS3X-E05/E12/E24	
Input	Rated Input Voltage	100 to 240V AC					
	Voltage Range (Note 1)	85 to 264V AC / 120 to 375V DC		88 to 264V AC / 125 to 375V DC			
	Frequency	47 to 63 Hz					
	Input Current	0.5A max.	0.65A max.	1.3A max.	1.8A max.	2.5A max.	
	Inrush Current (Ta = -25°C, ACV cold start)	at 115V AC	40A max.	30A max.	30A max.	30A max.	35A max.
		at 230V AC	60A max.	50A max.	50A max.	50A max.	70A max.
	Leakage Current	0.5mA max.		1.5mA max.	1.5mA max.	1.5mA max.	1.5mA max.
Efficiency (Typ.) (230V AC at input/ rated output)	5V	77%	77%	—	77%	77%	
	12V	81%	81%	81%	82%	81%	
	24V	82%	84%	84%	84%	84%	
Output	Rated Voltage/Current	5V, 3A	5V, 5A	—	5V, 12A	5V, 16A	
		12V, 1.3A	12V, 2.1A	12V, 4.2A	12V, 6A	12V, 8.5A	
		24V, 0.63A	24V, 1.1A	24V, 2.2A	24V, 3.2A	24V, 4.5A	
	Adjustable Voltage Range	±10%					
	Output Holding Time	13 ms typ. (100V AC) 60 ms minimum (230V AC)	10 ms typ. (100V AC) 60 ms minimum (230V AC)	23 ms typ. (100V AC) 60 ms minimum (230V AC)	14 ms typ. (100V AC) 60 ms minimum (230V AC)	17 ms typ. (100V AC) 80 ms minimum (230V AC)	
	Start Time	1000 ms max. (230V AC input, rated output)					
	Rise Time	50 ms max. (230V AC input, rated output)	30 ms max. (230V AC input, rated output)	30 ms max. (230V AC input, rated output)	30 ms max. (230V AC input, rated output)	30 ms max. (230V AC input, rated output)	
	Regulation <small>Ripple (including noise)</small>	Input Fluctuation	0.5% max.				
		Overvoltage Fluctuation	5V: ±2% max. 12V, 24V: ±1% max.				
		Temperature Fluctuation	0.04% / °C max. (-20 to +50°C)		0.04% / °C max. (-10 to +45°C)		
-20 to -10°C		5V: 200mV max. 12V/24V: 200mV max.	5V: 140mV max. 12V: 240mV max. 24V: 300mV max.	—	—	—	
		-10 to 0°C	5V: 160mV max. 12V/24V: 200mV max.	5V: 140mV max. 12V: 240mV max. 24V: 300mV max.	12V: 240mV max. 24V: 300mV max.	5V: 140mV max. 12V: 240mV max. 24V: 300mV max.	5V: 160mV max. 12V: 240mV max. 24V: 300mV max.
		PS3X-B, C: 0 to +50°C PS3X-D, Q, E: 0 to +45°C	5V: 100mV max. 12V/24V: 150mV max.	5V: 70mV max. 12V: 120mV max. 24V: 150mV max.	12V: 120mV max. 24V: 150mV max.	5V: 70mV max. 12V: 120mV max. 24V: 150mV max.	5V: 100mV max. 12V: 120mV max. 24V: 150mV max.
Supplementary Functions	Overcurrent Protection	105% min. (auto reset) ²					
	Overvoltage Protection	Voltage limitation at 115% min.		Intermittent operation or output off at 115% min. ³			
	Operation Indicator	green LED					
Dielectric Strength	Between input and output terminals	3000V AC, 1 minute					
	Between input and ground terminals	2000V AC, 1 minute					
	Between output and ground terminals	500V DC, 1 minute					
Insulation Resistance	100MΩ minimum, 500V DC megger (between input and output terminals, between input and ground terminals)						
Operating Temperature	-20 to +70°C (no freezing, see output derating)		-10 to +70°C (no freezing, see output derating)				
Operating Humidity	20 to 85% RH (no condensation)						
Storage Temperature	-40 to +85°C (no freezing)						
Storage Humidity	10 to 95% RH (no condensation)						
Vibration Resistance	10 to 55 Hz, 20m/s ² constant, 2 hours each in 3 axes						
Shock Resistance	200m/s ² , 1 shock each in 3 axes						
EMC	EMI	EN55022 Class B					
	EMS	EN55024					
Safety Standards	IEC/EN60950-1, UL60950-1, CSA C22.2 No. 60950-1						
Dimensions (H × W × D) (mm)	50.8H × 28W × 62D	50.8H × 28.5W × 79D	82H × 35W × 99D	95H × 38W × 129D	95H × 38W × 159D		
Weight (approx.)	130g	180g	340g	500g	700g		
Terminal Screw	M3						

OT Touchscreens

PLCs

Automation Software

Power Supplies

Sensors

Communication

Barriers



- See "Output Current vs. Input Voltage" characteristics next page. Not subject to safety standards. When using DC input, connect a fuse to the input terminal for DC input protection.
- Overload for 30 seconds or longer may damage the internal elements.
- One minute after the output has been turned off, turn on the AC input again.

Characteristics

Operating Temperature vs. Output Current (Derating Curves)

Conditions: Natural air cooling (operating temperature is the temperature around the power supply)

PS3X-B/C

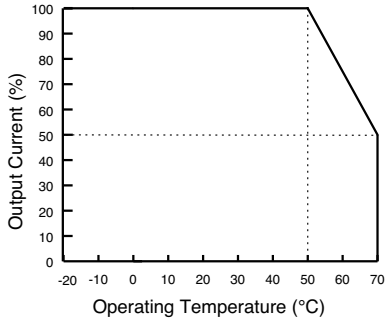

PS3X-D/Q/E

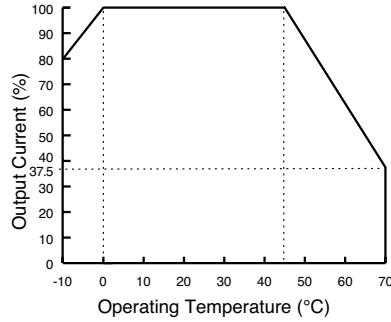

Overcurrent Protection Characteristics

PS3X

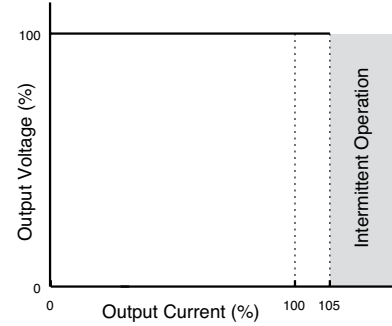

Output Current vs. Input Voltage (TA = 25°C)

PS3X-B/C

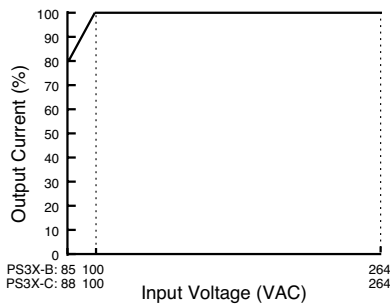

PS3X-D/Q/E

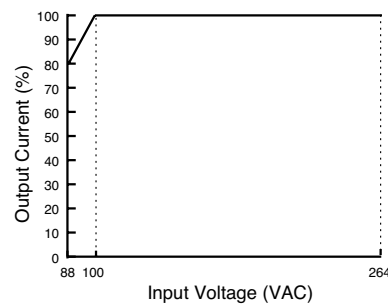

Operating Temperature by Safety Standards

Power Supplies	UL/EN60950-1
	Mounting A, B
PS3X-B05, -B12, -B24 PS3X-C05, -C12, -C24	50°C
PS3X-D12, -D24 PS3X-Q05, -Q12, -Q24 PS3X-E05, -E12, -E24	45°C

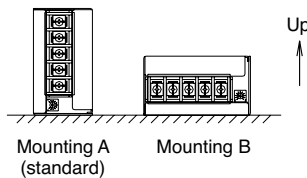

Note: Observe the derating curves when operating PS3X power supplies.

OI Touchscreens

PLCs

Automation Software

Power Supplies

Sensors

Communication

Barriers

Dimensions

PS3X-B

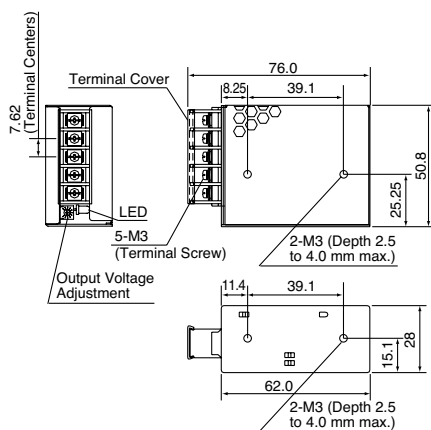

PS3X-C

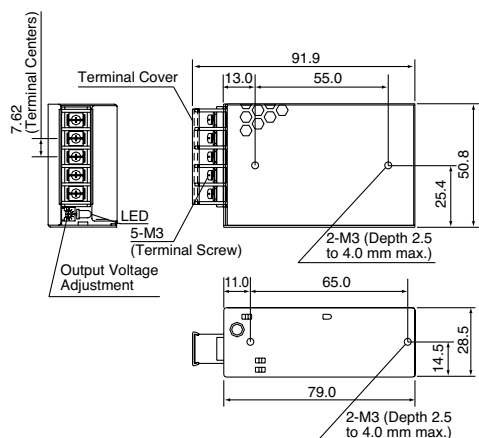

PS3X-D

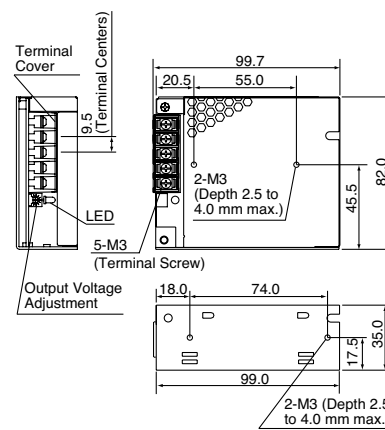

PS3X-Q

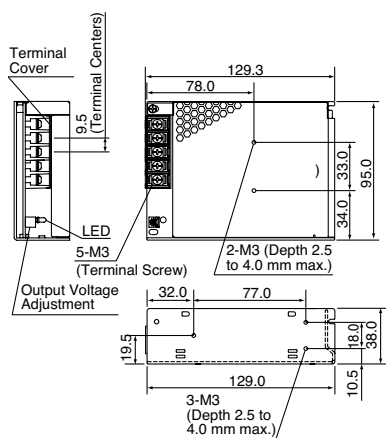

PS3X-E

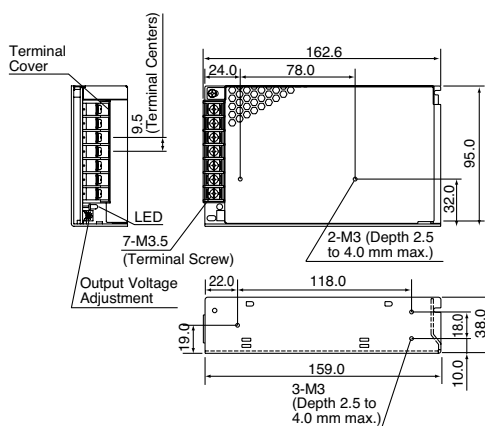

Terminal Markings

PS3X-B/C

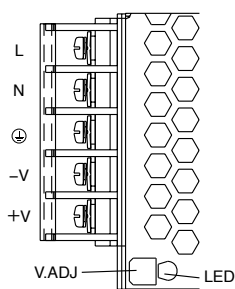

PS3X-D/Q

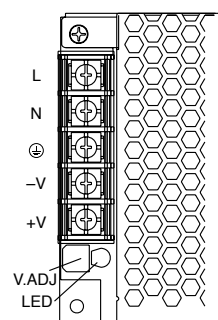

PS3X-E

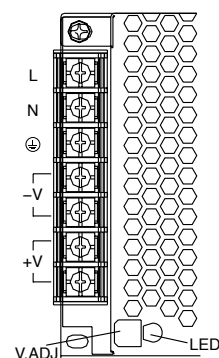

Marking	Name	Description
L, N	AC Input Terminal	Accepts a wide range of voltage and frequency. Polarity does not matter when using DC input.
⊕	Ground Terminal	Be sure to connect this terminal to a proper ground.
+V, -V	DC Output Terminals	Positive and negative output terminals
V.ADJ	Output Voltage Adjustment	Allows adjustment within ±10%. Turning clockwise increases the output voltage.
LED	Power status	Illuminates (green) when input power is applied.

01 Touchscreens

PLCs

Automation Software

Power Supplies

Sensors

Communication

Barriers

OT Touchscreens

L-shaped Mounting Bracket

PS9Z-3N3A (for 15W)

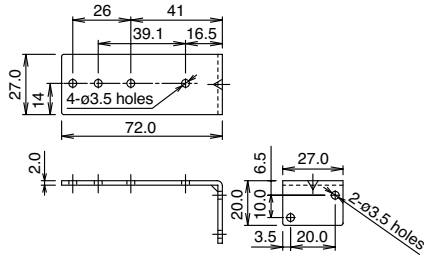

PS9Z-3N3B (for 25W)

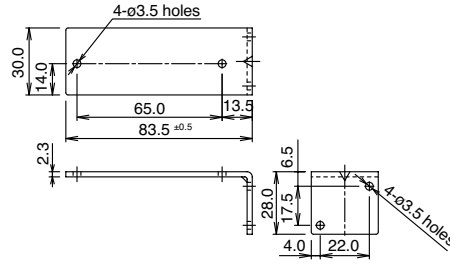

PLCs

PS9Z-3E3B (for 50W)

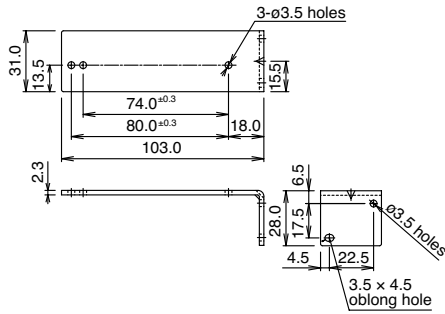

PS9Z-3N3E (for 75W/100W)

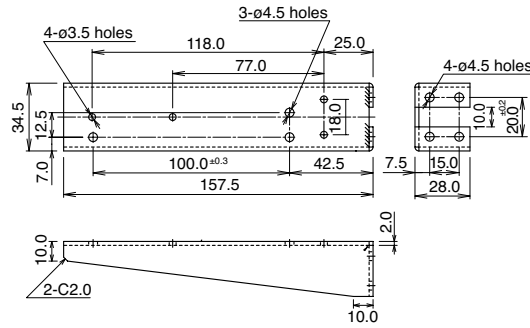

Automation Software

Power Supplies

DIN-rail Mounting Bracket

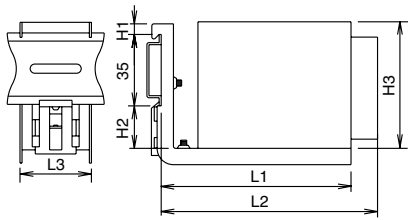

Part Number	Applicable Power Supply	L1	L2	L3	H1	H2	H3
PS9Z-3N4B	PS3X-B	95	105.5	35	5.2	20.5	50.8
	PS3X-C	95	113	35	5.2	20.5	50.8
PS9Z-3E4C	PS3X-D	136	117*	35	5.2	20.5	82
PS9Z-3E4D	PS3X-Q	188	141*	39.5	5.2	19.7	95
	PS3X-E	188	173*	39.5	5.2	19.7	95



* Note that L2 is shorter than L1.

Sensors

Communication

Barriers

Instructions

Installation Notes

- When mounting the PS3X switching power supply, see the figure on the right.
- See dimension drawings for mounting hole layouts.
- Use M3 screws for mounting. Choose screws that protrude 2.5 to 4mm from the surface of the switching power supply.
- Do not cover the openings of the switching power supply. Ensure proper heat dissipation by convection.
- Maintain a minimum of 20mm clearance around the power supply.
- When derating of the output does not work, provide forced air-cooling.
- Make sure to wire the ground terminal correctly.
- For wiring, use wires with heat resistance of 60°C or higher. Use copper wire.
- Recommended tightening torque of terminal screws: 0.8 N·m

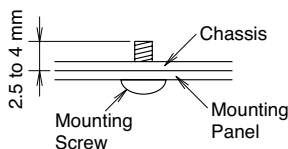
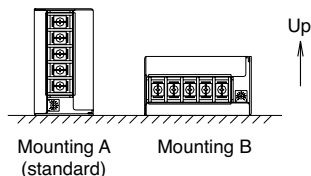

Adjustment of Output Voltage

The output voltage can be adjusted within $\pm 10\%$ of the rated output voltage by using the V.ADJ control. Turning the V.ADJ clockwise increases the output voltage. Turning counterclockwise decreases the output voltage. Note that overvoltage protection may work when increasing the output voltage.

Safety Precautions

- Do not use switching power supplies with equipment where failure or inadvertent operation may harm anyone, such as medical, aerospace, railway, nuclear, etc. PS3X switching power supplies are designed for use in general electric equipment such as office, communication, measuring, and industrial electric devices.
- Do not disassemble, repair, or modify the power supplies, otherwise electric shock, fire, or failure may occur.
- Do not install the switching power supply in places where someone will touch it when input voltage is applied. Do not touch the switching power supply while input voltage is applied and right after the power is turned off, because high temperature and high voltage may cause burns and electric shocks.
- Do not short circuit the output terminals or output lead wires, otherwise fire or damage may occur.
- Provide the final product with protection against failure or damage that may be caused by malfunction of the switching power supply. Damaged switching power supply may cause overvoltage on the output terminals, or may cause voltage drop.
- Turn off power before wiring. Also, make sure to wire correctly. Improper wiring may cause electric fire or damage.
- Do not use switching power supplies to charge rechargeable batteries.
- Make sure that the input voltage does not exceed the rating. Note polarity of input and output terminals and wire correctly. Incorrect wiring may cause blown fuses (AC input power), smoke or fire.
- Do not touch the inside of the switching power supply, and make sure that foreign objects do not enter the switching power supply, otherwise an accident or failure may occur.
- Observe the temperature derating curves. Operating temperature refers to the temperature around the lower part of the switching power supply. Failure to observe the derating curves could result in an internal temperature rise and possible failure of the switching power supply.
- The fuse inside the switching power supply is for AC input. When using with DC input, install an external fuse.
- Do not set the V. ADJ control over the setting range, otherwise performance deterioration or failure may occur.
- When failure or error occurs, shut down the input to the switching power supply, and contact IDEC.
- Do not use or store the switching power supply in a place subject to extreme vibration or shocks, otherwise failure will result.
- Do not use the switching power supply where it is subject to or near:
 - Direct sunlight, heat or high temperatures
 - Metal powder, oil, chemicals or hydrogen sulfide
 - Highly humid areas, such as a basement or conservatory
 - Inside freezers or refrigerators, near cooler exhaust, or other cold environments

Overcurrent Protection

The output voltage drops automatically when an overcurrent flows, resulting in intermittent operation. Normal voltage is automatically restored when the load returns to normal conditions. However, overcurrent for a prolonged period of time or short-circuit causes the internal elements to deteriorate or break down.

Overvoltage Protection

PS3X-B/C: Voltage limit and auto-recovery method. The switching power supplies operate normally when voltage returns to normal.

PS3X-D/Q/E: The output is turned off when an overvoltage is applied. When the output voltage has dropped due to an overvoltage, turn the input off, and after one minute, turn the input on again.

Series Operation

When connecting two switching power supplies in a series, insert a Schottky diode to each output.

Parallel Operation

Parallel operation is not possible.

Insulation/Dielectric Test

When performing an insulation/dielectric test, short the input (between AC) and output (between + and -). Do not apply or interrupt the voltage suddenly, otherwise surge voltage may be generated and the power supply may be damaged.

OI Touchscreens

PLCs

Automation Software

Power Supplies

Sensors

Communication

Barriers